

General Specifications

Electrical

Contact Rating4VA @ 24VDC (MAX) resistive 15 amps, 125 VAC 10 amps, 250 VAC 1/2 HP 125-250 VAC 20 amps, 4-14 VDC 15 amps, 15-28 VDC 10A 14VT 6A 125 VAC L
Dielectric Strength	1500 Volts RMS
Insulation Resistance	50 Megohms
Initial Contact Resistance.	10 milliohms max. @ 4 VDC
Life	50,000- 100,000 cycles circuit dependent
Contacts	Silver cad-oxide, silver tin-oxide, fine silver
Terminals	Brass or copper/silver plate 1/4" (6.3mm) Quick Connect terminations standard. Solder lug, Wire Lead

Mechanical

Endurance 150,000 cycles minimum

Physical Characteristics

Lighted	Incandescent - rated 10,000 hours Neon - rated 25,000 hours LED - rated 100,000 hours 1/2 life (LED is internally ballasted for voltages to 24 VDC)
Seals	Internal Optional external gasket panel seal
Base	Polyester blend rated to 125C with a UL flammability rating of 94 V-O.
Contura II, III, IV, V Actuator	Hard Surface: Basic actuator structure molded of thermoplastic polycarbonate with a hard Nylon 66 thermoplastic surface overlay. Soft Surface: Basic actuator structure molded of thermoplastic polycarbonate with an elastomer overlay.
Contura X, XI, XII Actuator, VP	Nylon 66 Reinforced rated to 105°C
Lens	Polycarbonate rated at 100°C

Actuator Travel (Angular Displacement)

2 position	18°
3 positions	9° from center

Mounting Specifications

Panel Thickness Range*

# of gaskets	Acceptable Panel Thickness
0	.030 to .250 (.76mm to 4.76mm)
1	.030 to .109 & .147 to .157 (.76 to 2.77mm & 3.73 to 3.98mm)
Recommended: No gasket with panel thickness of .032, .062, .093, .125, .187 or .250	

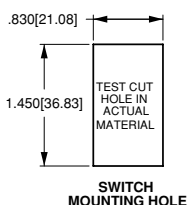

Agency Certifications



Environmental

Environmental	Sealed version: IP68, in accordance with IEC 529, BS 5490, DIN 400 50 & NFC 20 010. This rating applies to front panel components and signifies protection against dust and the prolonged effects of immersion under pressure. The standard test for immersion under pressure requires submersion under one meter of water for 30 minutes. The V-Series switch has exceeded these parameters, having been actuated and illuminated during submersion. NOTE: Sealed switch with optional panel gasket will meet IP67 rating.
Corrosion	Flowing Mixed Gas (FMG) Class III 3 year accelerated exposure per ASTM B-827, B-845 Silver and gold contacts
Operating Temperature	-40° C to + 85° C
Vibration 1	Per Mil-Std 202F, Method 204D Test Condition A 0.06 DA or 10G's 10-500 Hz. Tested with VCH connector. Test criteria - No loss of circuit during test and pre and post test contact resistance.
Vibration 2	Resonance search 24-50 Hz 0.40 DA 50-2000 ±10 G's peak Results Horizontal Axis 3-5 G's max. Random 24 Hz 0.06 PSD-Gsq/Hz 60 Hz 0.50 100 Hz 0.50 200 Hz 0.025 2000 Hz 0.025 No loss of circuit during test; <10µ seconds chatter.
Shock	Per Mil-Std 202F, Method 213B, Test Condition K @ 30G's. Tested with VCH connector. Test criteria - No loss of circuit during test, pre and post test contact resistance.
Salt Spray	Per Mil-Std 202F, Method 101D, Test Condition A, 48 Hrs. Sealed version only.
Dust	Per Mil-Std 810C, Method 510.2 Air Velocity 300 ±200 Feet/Min, Test Duration 16 Hrs.
Thermal Shock	Per Mil-Std 202F, Method 107F, Test Condition A, -55°C to 85°C. Test criteria - pre and post test contact resistance
Moisture Resistance	Per Mil-Std 202F, Method 106F, Test Criteria - pre and post test contact resistance
Ignition Protection	All Contura switches with sealed construction meet the requirements of UL1500/ISO8846 for ignition protection, in addition to conformance with EC directive 94/25/EC for marine products.

V-Series Dimensional Specifications: in.[mm]

CONTURA II STYLE

SHOWN WITH SQUARE LENS

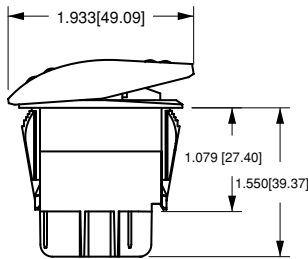
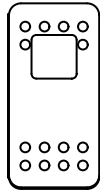

8 TERMINAL BASE W/BARRIERS

CONTURA III STYLE

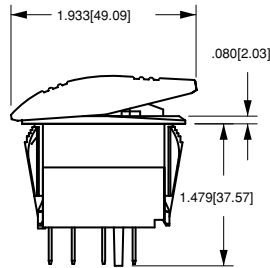
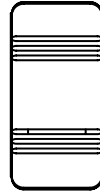

8 TERMINAL BASE W/O BARRIERS

CONTURA IV & V STYLE

IV - SHOWN WITH BAR LENS

V - SHOWN WITH ROUND LENS

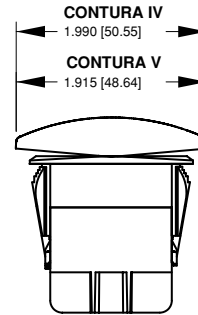
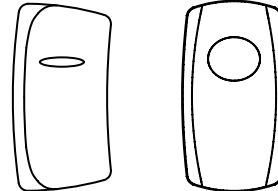

10 TERMINAL BASE W/BARRIERS

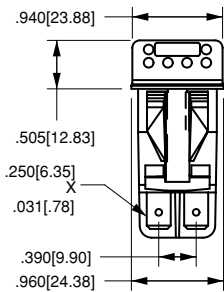

8 TERMINAL BASE W/BARRIERS

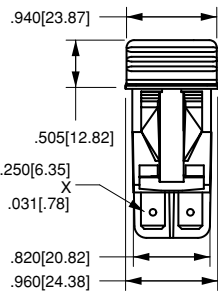

10 TERMINAL BASE W/BARRIERS

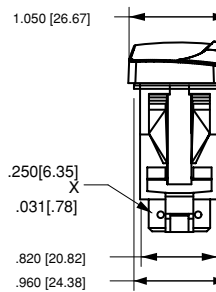

10 TERMINAL BASE W/O BARRIERS

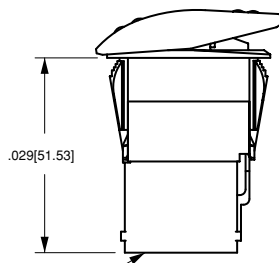

SWITCH SHOWN WITH VCH CONNECTOR 8 TERMINAL

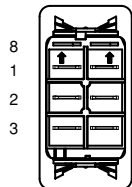

BOTTOM VIEW TERMINAL ARRANGEMENT 8 TERMINAL BASE

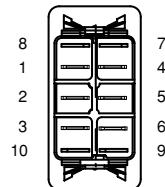

BOTTOM VIEW TERMINAL ARRANGEMENT 10 TERMINAL BASE

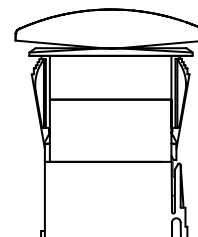

SWITCH SHOWN WITH VC1 CONNECTOR 10 TERMINAL

V-Series Dimensional Specifications: in.[mm]

CONTURA X STYLE
SHOWN WITH RAISED BRACKET

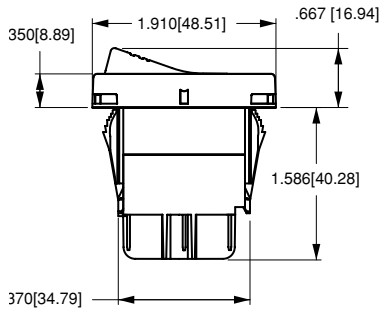
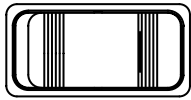

8 TERMINAL BASE W/BARRIERS

CONTURA XI STYLE
SHOWN WITH RAISED BRACKET AND TWO SQUARE LENSES

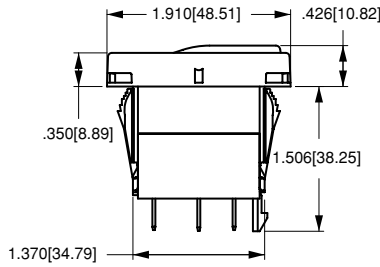
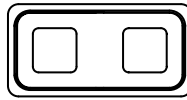

10 TERMINAL BASE W/O BARRIERS

CONTURA XII STYLE
SHOWN WITH PADDLE ACTUATOR

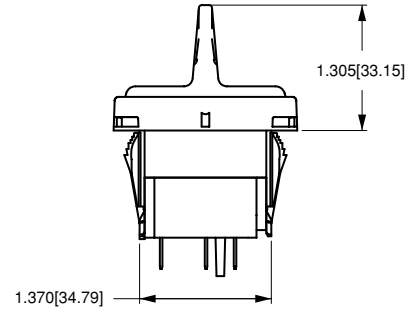
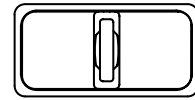

8 TERMINAL BASE W/O BARRIERS

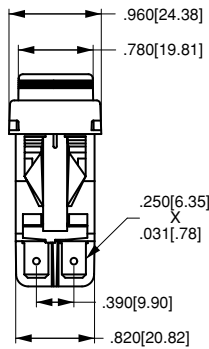

8 TERMINAL BASE W/BARRIERS

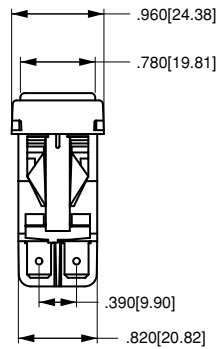

10 TERMINAL BASE W/BARRIERS

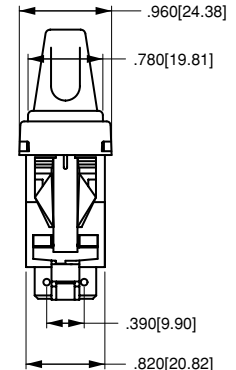

10 TERMINAL BASE W/O BARRIERS

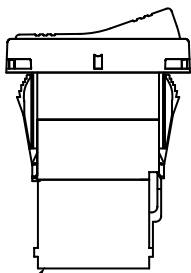

SWITCH SHOWN WITH VCH CONNECTOR 8 TERMINAL

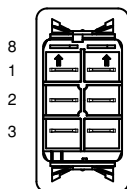

BOTTOM VIEW TERMINAL ARRANGEMENT 8 TERMINAL BASE

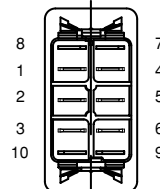

BOTTOM VIEW TERMINAL ARRANGEMENT 10 TERMINAL BASE

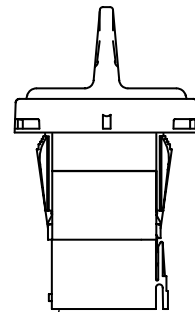

SWITCH SHOWN WITH VC1 CONNECTOR 10 TERMINAL

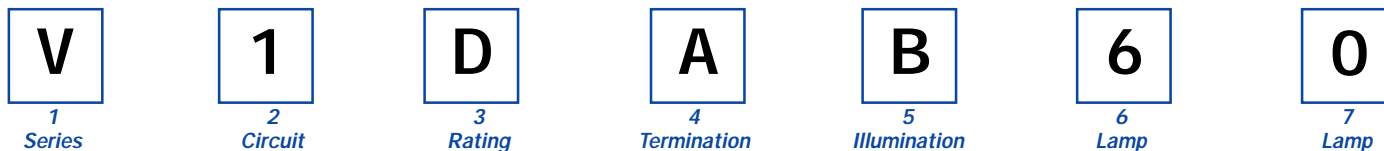

1 SERIES

V

2 CIRCUIT

Terminal Connections as viewed from bottom of switch:

8 terminal	10 terminal
8 - 7	8 - 7
1 - 4	1 - 4
2 - 5	2 - 5
3 - 6	3 - 6
	10 - 9

() - momentary
 SP - single pole - uses terminals 1, 2 & 3.
 DP - double pole uses terminals 1, 2, 3, 4, 5 & 6.
 Terminals 7, 8, 9 & 10 for lamp circuit only.

Position:	1	2	3
	2 & 3	CONNECTED	1 & 2
SP DP	5 & 6	TERMINALS	4 & 5
1	A ON	NONE	OFF
2	B (ON)	NONE	OFF
3	C ON	NONE	(OFF)
4	D ON	NONE	ON
5	F ON	NONE	(ON)
6	J ON	OFF	ON
7	K ON	OFF	(ON)
8	L (ON)	OFF	(ON)

SPECIAL CIRCUITS

H*	2 & 3	2 & 3, 5 & 4	5 & 4
G*	2 & 3, 5 & 6	2 & 3	OFF
S	2 & 3, 5 & 6	2 & 3	1 & 2
M*	(2 & 3, 5 & 6)	2 & 3	OFF
R	(2 & 3, 5 & 6)	2 & 3	1 & 2
E*	5 & 6	5 & 3	5 & 1

* Jumper between terminals 2 & 5 for circuits H, G, & M to be specified in selection 4. External jumper between terminals 2 & 4 for circuit E are to be provided by customer. Circuit E may be used for SP OFF-ON-ON circuit. Special circuits H, M & E not available with ratings 5 through 9.

3 RATING

- 1** .4VA @ 28VDC Resistive
- 4** 10A 250VAC 1/2 HP, 15A 125 VAC 1/2 HP
No Agency Listings
- 5** 10A 250VAC 1/2 HP, 15A 125 VAC 1/2 HP
UL Recognized, CSA Certified
- 6*** 15A 125VAC 1/2 HP, 12(2)A 125 VAC μ T85
- 7*** 15A 125VAC 1/2 HP, 12(6)A 125 VAC T85
- 8*** 10A 250VAC, 15A 125VAC, 1/2 HP 125-250 VAC, 12(2)A 250 VAC μ T85
- 9*** 10A 250VAC, 15A 125VAC, 1/2 HP 125-250 VAC, 12(6)A 250 VAC T85
- B** 15A 24V
- C** 20A 18V
- D** 20A 12V
- E** 20A 14V, 10A 14VT (circuits 1, 4, A, & D only)
- F** 10A 14V, 6A, 14VT (circuit G only)
- G** 20A 6V
- H** 20A 3V
- L** 15A 125 VAC, 10A 250VAC, 1/2 HP 125-250 VAC; 6A 125 VAC L
- M** .4VA/20A 12V (combi-contact)
- N** .4VA/15A 24V (combi-contact)

* Ratings 6 to 9 are UL, CSA, VDE, DEMKO, SEMKO, NEMKO, FIMKO & BEAB certified, require terminations A or B for double pole circuits, & are not available with illumination circuits 4, 8, D, J, N, & T or with wire lead or solder lug terminations. Circuits 1, 4, A & D are not available with rating 6 & 8. Rating 7 & 9 only available with circuits 1, 4, A & D. Circuits 2, 3, 5, 7, 8, K, L are 1/2 HP 250VAC only with rating 8. Ratings 6 & 7 must specify lamp code 1 (125VAC neon). Ratings 8 & 9 must specify lamp code 2 (250VAC neon). Rating L available with circuits 1, 4, A & D only.

4 TERMINATION/BASE STYLE

8 Base	10 Termination	Jumper
1	2 .250 TAB (QC) no barriers	No
A	B .250 TAB (QC) with barriers	No
J	K .250 TAB (QC) no barriers	Yes T2 to 5
3	4 Solder Lug no barriers	No
C	D Solder Lug with barriers	No
5	6 Wire Leads no barriers	No
E	F Wire Leads with barriers	No

Note: Codes J & K for circuits H, G & M. Ratings 6, 7, 8 & 9 require terminations A or B only.

5 ILLUMINATION & SWITCH SEALING

Lamp #1 located above terminals 1 & 4 end of switch.
 Lamp #2 located above terminals 3 & 6 end of switch.
 Positive (+) and negative (-) symbols apply to LED lamps only.

SEALED	UNSEALED	LAMPS ILLUMINATED	ACTUATOR LENS POSITION WHEN WIRED TO	LAMP WIRE TO TERMINALS
S	0	None		
A	1	# 1 Independent	8+	7-
B	2	# 1 Down	3+	7-
C	3	# 2 Up	3+	7-
D	4	# 1 Down & # 2 Down	3+ 1+	7- 7-
E	5	# 1 Up & # 2 Up	1+ 3+	7- 7-
F	6	# 1 Independent & # 2 Up	8+ 3+	7- 6-
G	7	# 1 Independent & # 2 Up	8+ 3+	7- 7-
H	Z	# 2 Independent	8+	7-
U	Y	# 1 Independent & # 2 Independent	8+ 10+	7- 9-

Selections for Single Pole Switches Only:

J	8	# 1 Down & # 2 Independent	3+ 6+	8- 7-
K	W	# 1 Independent & # 2 Independent	8+ 6+	7- 7-

Selections for Double Pole Switches Only:

L	9	# 1 Down	3+	6-
M	R	# 2 Up	3+	6-
N	T	# 1 Down & # 2 Down	3+ 1+	6- 4-
P	V	# 1 Up & # 2 Up	1+ 3+	4- 6-

6, 7 LAMP

Selection 6: above terminals 1 & 4; Selection 7: above terminals 3 & 6
 USE SAME CODING FOR BOTH SELECTIONS

	0 - NO LAMP THIS LOCATION			
	Neon 1 - 125VAC 2 - 250VAC			
	Incandescent 4 - 3V 5 - 6V 6 - 12V 7 - 18V 8 - 24V			
LED*		superbright	superbright	
	Red	Amber	Green	Red
2VDC	A	L	F	R
6VDC	B	M	G	S
12VDC	C	N	H	T
24VDC	D	P	J	V

* Consult factory for "daylight bright" LED options. Typical current draw for LED is 20ma.

1	-	6	P	Z	00	-	0	00
8 Bracket		9 Actuator	10 Lens	11 Lens	12 Legend		13 Orientation	14 Legend

8 BRACKET COLOR¹, PANEL SEAL (External Foam Gasket)

Contura X & XI with flush bracket

of gaskets: 0 1 2
 Bracket Color:

Black	B	C	D
White	W	Y	Z
Gray	G	H	J

Contura X, XI, & XII with raised bracket

of gaskets: 0 1
 Bracket Color:

Black	1	4
White	2	5
Gray	3	6

9 ACTUATOR

0 - No Actuator (Furnished Separately)

	Black	Gray	White	Red	Lens style & location
Contura X	1	2	3	4	
Contura XI	6	7	8	9	
Contura XII	J	K	N	M	

10 LENS - ABOVE LAMP #1 TERMINALS 1,4

11 LENS - ABOVE LAMP #2 TERMINALS 3,6

Lens color for LEDs must be clear, white, or match color of LED. Green or blue lenses are not recommended with Neon lamps.

0 - No Actuator		Z - No Lens			
Clear	White	Amber	Green	Red	Blue
3	8	D	J	P	V
4	9	E	K	R	W
5	A	F	L	S	Y
					Two piece square lens
2	7	C	H	N	U
					Two piece square lens
1	6	B	G	M	T
					Two piece square lens

*All bottom lenses will be molded of opaque material. Consult factory for other lens colors.

12 ACTUATOR LENS OR BODY LEGENDS²

00 - NO LEGEND THIS LOCATION/NO ACTUATOR

Contura X & XI		Contura XII	
11 ON OFF	15 O O F N F	21 OFF	25 O F F
12 OFF ON	16 O O N F F	22 ON	26 O N
13 O	17 O	23 O	27 O
14 O 	18 O	24 	28

For additional legend options & codes, see page 34 of this catalog

13 LEGEND ORIENTATION⁴

Field 13 must be 0 if legend code in selection 12 is 11 - 18 or 21 - 28. Center of actuator marking is not available for Contura XII.

0 - NO LEGEND

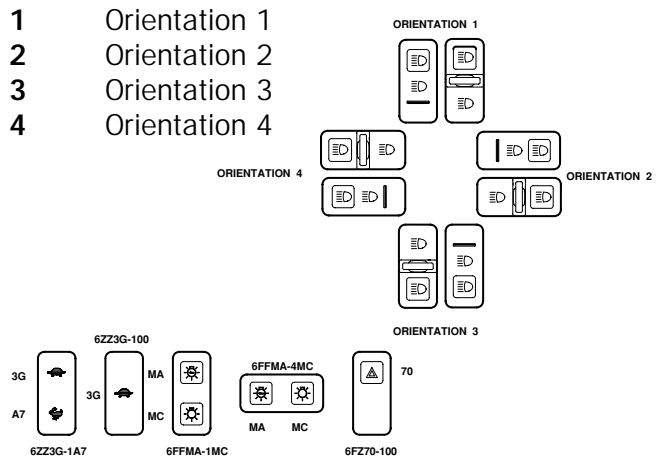

14 ACTUATOR LENS LEGENDS

Field 14 must be 00 if legend code in selection 12 is 11 - 18 or 21 - 28.

00 - NO LEGEND this location/NO ACTUATOR

Selection 14 required when switch requires two legends. If the two legends consist of one lens and one body legend, lens legend must be specified in selection 12; body legend specified in selection 14.

For legend options & codes, see page 34 of this catalog

NOTES

Shading indicates standard configurations.

To order components separately:

Switch without actuator, specify: V with code selections 2 - 8. (ex.) V1DABC01-00000-000.
 Actuator with lenses, specify: VV with code selections 9-14.
 Actuator & lenses separately consult factory.

Consult factory to verify horsepower rating for your particular circuit choice.

- Custom colors are available. Consult factory.
- White imprinting is standard on black actuators; Black imprinting is standard on white, red and gray actuators; Custom colors are available, consult factory.
- With two square lenses, use selection 12 for lens above lamp 1, and use selection 14 for lens above lamp 2.



Contura X



Contura XI



Contura XII